



Hot Melt Gutta Percha Filling Machine Instruction Manual



Fi-P & Fi-G

Guilin Woodpecker Medical Instrument Co., Ltd.

www.stomshop.pro

Contents

(Fi-G)

| | |
|--|----|
| Introduction ----- | 1 |
| 1 Product introduction----- | 1 |
| 2 Standard icons----- | 9 |
| 3 Contraindications ----- | 9 |
| 4 Installation and disassembly method of accessories ----- | 9 |
| 5 Operation method ----- | 11 |
| 6 Charging instruction----- | 13 |
| 7 Safety precautions ----- | 13 |
| 8 Maintenance ----- | 14 |
| 9 Troubleshooting ----- | 16 |
| 10 After-sales service----- | 17 |
| 11 Environment protection----- | 18 |
| 12 Statement ----- | 18 |

(Fi-P)

| | |
|--|----|
| Introduction ----- | 19 |
| 1 Product introduction----- | 19 |
| 2 Standard icons----- | 24 |
| 3 Contraindications ----- | 24 |
| 4 Installation and disassembly method of accessories ----- | 25 |
| 5 Operation method----- | 26 |
| 6 Charging instruction----- | 26 |
| 7 Safety precautions ----- | 27 |
| 8 Maintenance ----- | 27 |
| 9 Troubleshooting ----- | 28 |
| 10 After-sales service----- | 29 |
| 11 Environment protection----- | 29 |
| 12 Statement ----- | 30 |

Introduction

Thank you for purchase Fi-G Hot Melting and Filling Gun developed by Guilin Woodpecker Medical Instrument Co., Ltd, a Hi-tech enterprise developing, manufacturing, and selling dental instruments. Woodpecker has excellent Quality Control System. To guarantee correct and safe operation, please read this Instruction Manual carefully before use. Depending on the level of risk involved, safety requirements are classed under the following indications:



Danger: (always referred to personal injury)



warning: (referred to possible damage to property)

1 Product introduction

1.1 Intended use

Heat up and soften gutta-percha, and fill the gutta-percha into the root canal after preparation.

1.2 Diagram of components and control buttons

The Fi-G is equipped with a display screen and a control button on both the left and right sides. And the design of left and right sides are perfectly symmetrical, which enables either left-hand or right-hand operation;

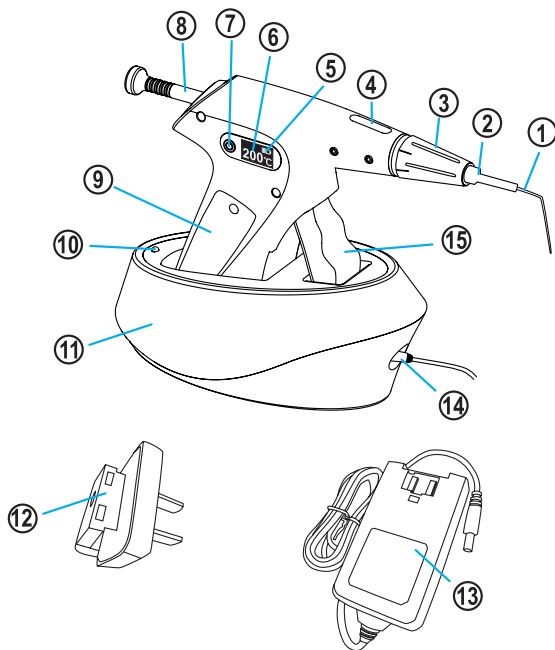

- | | |
|--|------------------------------|
| 1. Gutta-percha injection needle | |
| 2. Heat insulation sleeve for injection needle | |
| 3. Heat insulation hood | 4. Gutta-percha loading slot |
| 5. Battery level | 6. Temperature |
| 7. “ON/OFF” button | 8. Pushing ram |
| 9. Battery cover | 10. Charging indicator |
| 11. Charging base | 12. Power adapter plug |

13. Power adapter

14. Connecting hole for power supply

15. Trigger

1) “ON/OFF” button:

a) In the OFF state, long press the left or right “ON/OFF” button can turn on the power. After the power is turned on, the left and right displays will be lit at the same time.

b) In the ON state, long press the left or right “ON/OFF” button can turn off the power.

Note: If there is no operation for 10 minutes, the Hot Melting and Filling Gun will automatically shut down.

2) Temperature control button: (Note: The temperature control button and the “ON/OFF” button are the same button. After powers on, the button acts as temperature control button.)

Lightly press the button to change the preset temperature for heating the gutta-percha. The temperature will change in the sequence of 150°C→180°C→200°C→230°C as shown in Figure 1, and back to 150°when you press the button in 230°C.



Figure 1 Preset temperature

| Gutta-percha injection needle | Temperature |
|-------------------------------|-------------|
| 25G | 180°C-230°C |
| 23G | 180°C-200°C |
| 20G | 180°C-200°C |

Table 1 Recommended temperature setting

3) Battery level:

The actual power of the battery is displayed in real time on the screen. When the battery is fully charged, the power of the OLED display is displayed as five grids. When the battery level is one grid, it indicates that the battery is low and needs to be charged in time. When the battery level is displayed as a space, it indicates that the battery is very low and needs to be charged immediately.

Note: During normal use, try not to let the battery level reduced to space status (completely no power) before charge, which will shorten the service life of battery.

Warning:

If the device has not been used for more than one month, the battery needs to be recharged. If the device is not in use for a long time, please be sure to charge it at least once a month to protect the battery. The service life of battery of Melting and Filling Gun will be shortened when it is in a low battery state for a long time or when it leaves the charging base for a long time.

4) Temperature:

When the temperature is preset, the display screen shows the preset temperature value. About 1s after the temperature preset, the OLED

screen will display the real-time temperature inside heating chamber.

When the Melting and Filling Gun is in the heating state, the temperature indicator will simultaneously display the current temperature.

5) Charging base:

Firstly, connect the power adapter plug to the power adapter as shown in Figure 2. Then connect the power adapter to the charging base as shown in Figure 3 and connect the power adapter to a standard socket. Place the Melting and Filling Gun correctly on the charging base as shown in Figure 4, so that the charging connector under the Melting and Filling Gun can be reliably connected to the output connector of the charging base. When the Melting and Filling Gun is properly connected to the charging base, the LED charging indicator on the base will be on constantly. If the LED is flashing or not lit, please check all the cables carefully.

There are charging status indicators on the charging base. When the Melting and Filling Gun is not placed on the charging base, the indicator will flashes in yellow and green alternately. When the Melting and Filling Gun is placed on the charging base, if the charging is being charged, the yellow indicator will be on constantly. When the battery is full, the yellow indicator will be off and the green indicator will be on constantly.

Notes: After receiving the device, please charge it immediately. Before use, please be sure that battery is fully charged. When the device is fully charged, the battery level of the Melting and Filling Gun LED display screen is the highest. After the battery runs out, the time of battery charging takes at least 2 hours and 30 minutes.

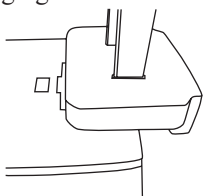

Figure 2 Installation of power adapter

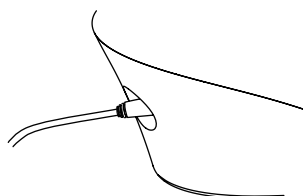

Figure 3 Connection to power supply

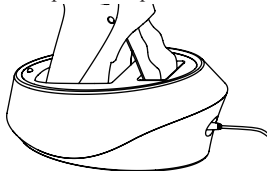
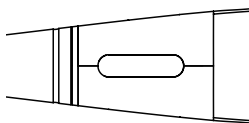

Figure 4 Charging

6) Gutta-percha loading slot:

Note: Only gutta-percha can be loaded into it for a time.



7) Heat insulation hood:

The design of heat insulation hood is to protect the oral soft tissue and lip from scalding.

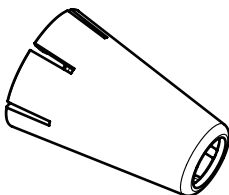

Note: Before being used to different patients or before each use, please clean, disinfect and sterilize the heat insulation hood.

8) Gutta-percha injection needle



Before use, the gutta-percha injection needle and the Fi-G must be connected and tightened with the wrench provided by our company to prevent the injection needle from falling off or the gutta-percha leakage during use. But do not to screw too tight. Here we provide a variety of injection needles with different sizes (Please refer to Table 2), and the injection needles can be pre-bent depending on the application. (Note: Store unused gutta-percha injection needles in a sealed environment, as the gutta-percha injection needle are made of silver and may discolor due to oxidation caused by long-term exposure to air). Please use the wrench provided by the company to connect, disassemble and pre-bend the gutta-percha injection needle.

Note: When replace the gutta-percha injection needle, please first power off and wait for 5 minutes. Only after the Melting and Filling Gun and gutta-percha injection needle cool down, the replacement can start. When the gutta-percha injection needle is still hot, to avoid scalding, please do not pre-bent or replace the gutta-percha injection needle.

 **Warning:**

Before being used to different patients or before each use, please

clean, disinfect and sterilize the gutta-percha injection needle. It is recommended that users follow manufacturer's written instructions to properly disinfect the device; the Melting and Filling Gun cannot be autoclaved. Do not autoclave the Melting and Filling Gun and charging base or place them in chemical disinfectants.

9) Wrench:

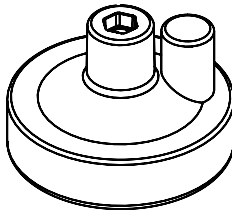

The wrench is used to tighten the gutta-percha injection needle and its connection to Melting and Filling Gun. After tighten the gutta-percha injection needle, the needle can be bent to any suitable angle with wrench. Do not use other instruments to pre-bend the needle other than the wrench provided by manufacturers.

10) Cleaning brush:

When cleaning the heating chamber with a cleaning brush, first set the preset temperature of the Melting and Filling Gun to 200 °C, then insert the cleaning brush into the back of the Melting and Filling Gun, and then push it hard to ensure that the cleaning brush is removed from the front of the heating chamber. Do not remove the cleaning brush from the back of the Melting and Filling Gun. When cleaning, you can repeat the cleaning for several times to ensure that the heating chamber is well cleaned.

1.3 Device includes

1. Melting and Filling Gun
2. Charging base
3. Power adapter with cord
4. Gutta-percha injection needles (The models are as shown in Table 2)
5. Heat insulation hood
6. Heat insulation sleeve for injection needle
7. Cleaning brush
8. Pushing ram
9. Wrench
10. Instruction Manual
11. Qualified Certification

12. Warranty card

13. Packing list

| Model | Gauge | Length |
|--------------|--------------|---------------|
| 20G 22mm | 20G | 22mm |
| 20G 24mm | 20G | 24mm |
| 20G 28mm | 20G | 28mm |
| 23G 24mm | 23G | 24mm |
| 23G 28mm | 23G | 28mm |
| 25G 24mm | 25G | 24mm |

Table 2 Models of gutta-percha injection needles

1.4 Introduction and scope of application

1.4.1 Features:

a) Symmetrical two-sided display and operation button design for left or right hand operation.

b) Cordless design for Melting and Filling Gun effectively broadens the operation space.

c) Sensitive temperature control, simple display, and convenient operation; Press temperature setting button to set suitable working temperature.

d) Four preset temperatures are for option: 150°C, 180°C, 200°C, 230°C

e) Safe protecting system. If there is no operation for 10 minutes, the Melting and Filling Gun will automatically shut down.

1.4.2 Scope of application:

Only used in endodontic filling with gutta-percha or root canal sealant. Fi-G is equipped with gutta-percha injection needle and heat insulation hood to heat up and soften gutta-percha to backfill root canal.

1.5 Product specifications

| | | |
|--------|-------------------------|------------------------|
| Sizes | Melting and Filling Gun | 31.9mm×152.5mm×114.9mm |
| | Charging base | 75.5mm×149.7mm×62.6mm |
| Weight | Melting and Filling Gun | 170g |
| | Charging base | 207g |
| | Power adapter | 167g |

1.6 Technical parameters

| | |
|----------------|-------------------------------|
| Classification | Class II(AC/DC power adapter) |
|----------------|-------------------------------|

| | | |
|-------------------------------|---------------------------------------|------------------------------|
| Optional preset temperatures | 150°C→180°C→200°C→230°C | |
| Time consumption for charging | About 2.5h (First charging needs 3 h) | |
| Power supply | Input | AC100V-240V 50/60Hz 800mA |
| | Output | DC15V/1.6A |
| Battery capacity | Chargeable battery | 2000mAh |

1.7 Environmental parameters

| | | |
|-------------------|--------------|----------------|
| Working condition | Temperature | +5°C ~ +40°C |
| | Humidity | 30% ~ 75% |
| | Air pressure | 70kPa ~ 106kPa |

1.8 Storage and transport

1. The device should be handled carefully and lightly. Be sure that it is far from the vibration, and is installed or kept in a cool, dry, and ventilated place.

2. Do not store the device together with the articles that are combustible poisonous, caustic, or explosive.















3. The device should be stored in a room where the relative humidity is 10% ~ 93%, the air pressure is 70kPa ~ 106kPa, and the temperature is -20°C ~ +55°C.

4. Please avoid the device from strong shock or vibration during transport. And please handle it carefully.

5. Please do not mix the device with hazardous articles during transport.

6. Please avoid the device from sun, rain, and snow during transport.

2 Standard icons

| | | | |
|---|--|---|-------------------------------------|
|  | Product serial number |  | Follow Instructions for Use |
|  | Manufacturer |  | Date of manufacture |
|  | Type B applied part |  | Class II device |
|  | Power switch | IPX0 | Ordinary equipment |
|  | Used indoor only |  | Device complies with WEEE directive |
|  | Can be autoclaved | DC 15V | DC 15V |
|  | Attention! Please refer to the accompanying documents. | | |
|  | Humidity limit for storage: 10% ~ 93% | | |
|  | Atmospheric pressure for storage: 70kPa ~ 106kPa | | |
|  | Temperature limit for storage: -20°C ~ +55°C | | |

3 Contraindications

1. People who are allergic to known natural latex and metals such as stainless steel, silver, copper, etc. are prohibited to use this device.
2. The patient with hemophilia is forbidden to use this device.
3. The patients with heart pacemaker are forbidden to use this device.
4. The dentists with heart pacemaker are forbidden to use this device.
5. Heart disease patients, pregnant women and children should be cautious to use the equipment.

4 Installation and disassembly method of accessories

4.1 Connection of power adapter

Connect the output point of power adapter to the charging base, and

connect the input point to the socket that meets the standard of this power adapter. Please install in accordance with the procedures in Figure 2, Figure 3, and Figure 4.

4.2 Installation, disassembly and pre-bent of gutta-percha injection needle

Note: In order to prevent from scalding, when replace the gutta-percha injection needle, please first power off and wait for 5 minutes. Only after the heating point cools down, the replacement can start.

1. Power off the device and wait for 5 minutes until the Melting and Filling Gun cools down. And then use wrench to disassemble the injection needle in counter-clockwise direction.

2. Place the used needle in the dedicated container.

3. Select needed gutta-percha injection needle (20ga, 23ga or 25ga. Please refer to Table 2 for details.), and tighten the injection needle to the Melting and Filling Gun in clockwise direction. Please be cautious not to over tighten.

4. Use wrench to bend the needle to needed angle.

4.3 Installation and disassembly of heat insulation hood

Start installation and disassembly from head part of the Melting and Filling Gun.

4.4 Removal and replacement of battery

When replace the battery, first loosen the fixing screw with a screwdriver, then remove the battery cover, next remove the old battery, replace it with a new one, and finally cover the battery cover and tighten the screws.

4.5 Installation and disassembly of pushing ram

The pushing ram can only be plugged in or unplugged from tail part of the Melting and Filling Gun.

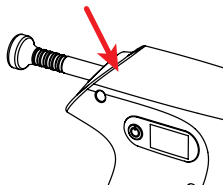

5 Operation method

Note: During use, please do not contact the heating part of the Melting and Filling Gun. Before use, remember to install the heat insulation hood to prevent users or patients from scalding.

1. Choose gutta-percha injection needle

Choose suitable gutta-percha injection needle (20ga, 23ga or 25ga) according to the situation of patient. And tighten the gutta-percha injection needle and handpiece (Note: not too tight). Note: the 23ga and 25ga rotating type gutta-percha injection needle can rotate to suitable angle within the range of 360° in clockwise direction and counter-clockwise direction. And you can also use wrench to pre-bend the needle and adjust it to a better operation angle as per your needs.



Warning:

When install the gutta-percha injection needle, please be sure that the device is off and the head part of the device is cooling down. (About 5 minutes after shutdown of the Melting and Filling Gun, the head part of it can cool down to the temperature that allows people to touch.)

2. Choose the gutta-percha

Choose suitable gutta-percha for the device. Before loading it into the loading slot, pull the pushing ram back (do not pull out) to empty the loading slot, and then tilt the head of the gun down. After tilting the head part for an certain angle, put the gutta-percha into the loading slot, and then use the pushing ram to push the gutta-percha into the heating chamber completely (Note: only one gutta-percha stick can be placed at a time). When the gutta-percha completely enters the heating chamber, the black marker circle of the pushing ram will fully advance into the gun. Failure to fully fit the gutta-percha into the heating chamber will result in function failure of the device.

3. Power on

After powering on with long press on “ON/OFF” button, the device will automatically heat up to the preset temperature. If you want to change the preset temperature, please continuously press the temperature control button until the display screen displays the needed temperature value. After each press, the temperature will change once in the sequence of 150°C->180°C->200°C->230°C. And it will back to 150°C when you press the button while at 230°C. During operation, please refer to Table 1 Recommended temperature setting to set suitable temperature.

One second after setting suitable temperature, the display screen will automatically skip to display the actual heating temperature. And it will heat up until reach the preset temperature. Pull the trigger to push the pushing ram forward until there is a small amount of extrusive gutta-percha in the needle.

Note: The displaying temperature is the temperature inside the heating chamber.

4. Canal obturation

Install the heat insulation hood at the connecting part of gutta-percha injection needle and Melting and Filling Gun, and wipe the filling material from the needle with gauze and alcohol. Note: The needle is hot at this time, and the injection needle starts filling from the bottom of the root canal to reduce or avoid the generation of bubbles. Place the needle at the bottom of the root canal. Pull the trigger to squeeze the gutta-percha, and slowly retract the needle until reach the crown hole.



Warning:

When the trigger is squeezed to fill the gutta-percha without retracting the needle, the injection needle may break. While the gutta-percha is still hot, use a medical vertical presser to squeeze down. If there are bubbles in the root canal, use a small amount of material to fill the root canal for many times. Use a little more material for each filling and use vertical presser to press it down.

5. Replacement of gutta-percha

When the trigger is pushed forward to push the push ram to make a "click" sound, it indicates that the gutta-percha in the Melting and Filling Gun has been used up. And it is necessary to load a new gutta-percha stick in time. When loading another gutta-percha stick, make sure the filling gun has cooled to room temperature. When the previous gutta-percha has been completely squeezed out, then according to step 2, re-select the appropriate gutta-percha for loading.



Warning:

Do not replace the gutta-percha stick in the heated state, otherwise it may cause scalding or damage the Melting and Filling Gun.

6. After operation, the remaining materials in the heating chamber must be cleaned, and the relevant accessories must be cleaned, disinfected and sterilized. For details, see Chapter 8.1.

6 Charging instruction

6.1 Use corresponding charging base for charging: Connect the power adapter to the charging base, and connect to power supply. And then correctly place the Melting and Filling Gun in the charging base. When the Melting and Filling Gun is not placed on the charging base, the indicator will flashes in yellow and green alternately. When the Melting and Filling Gun is placed on the charging base, if the charging is being charged, the yellow indicator will be on constantly. When the battery is full, the yellow indicator will be off and the green indicator will be on constantly. Under normal situation, the charging takes about 2.5h.

6.2 The battery used in this product has no memory and can be used at any time or charged at any time.

6.3 Before first use of this device, please charge it at least for 3 hours.

7 Safety precautions

1. Do not use instruments other than the provided wrench to install, disassemble or pre-bent gutta-percha injection needle.

2. Do not knock or scratch the Melting and Filling Gun.

3. Do not place the Melting and Filling Gun near an electronic device, phone, radio or HD/satellite TV as these may affect the temperature control of the Melting and Filling Gun.

4. Keep heat carrier accessories such as Melting and Filling Gun, gutta-percha injection needle, heat insulation hood etc. under heating state away from inflammable and explosive materials.

5. Please keep the device clean before and after operation. Before each use, please clean, disinfect and sterilize the accessories such as gutta-percha injection needle, heat insulation hood and wrench.

6. Users should be equipped with adequate protection such as goggles, mask, etc. to prevent cross-infection.

7. The product should be in strict accordance with relevant operation specifications of medical authority and relative regulations. The product can only be operated by trained doctors or technicians.

8. Do not install, remove, or replace the heat insulation hood and injection needle under heating state. If you need to replace the injection needle, please first power off and wait for 5 minutes. Five minutes later, if the Melting and Filling Gun totally cools down, replace the injection needle.

9. The injection needle must be correctly installed to prevent from falling off or gutta-percha leakage during operation.

10. Do not use excessive force when pre-bending the injection needle to prevent the injection needle from breaking. When the injection needle is bent or worn, the gutta-percha flowing ability may be deteriorated, and the operator should replace the new injection needle in time according to the clinical condition;

11. Woodpecker is specialized in producing medical instrument.

We are only responsible for the safety on the following conditions:

a) The maintenance, repair, and modification are made by the manufacturer or the authorized dealers.

b) The charged components are original of “Woodpecker” and operated according to instruction manual.

8 Maintenance

8.1 cleaning, disinfection and sterilization

After use, squeeze out all the residual materials inside heating chamber, power off the device, pull the pushing ram out of Melting and Filling Gun from the back side, and remove the material on the top of pushing ram.

1) Cleaning of charging base and Melting and Filling Gun

The charging base and the surface of Melting and Filling Gun can be wiped with a soft towel with a small amount of neutral detergent or disinfectant alcohol.

2) Heat insulation hood

Before first use and before used to different patients, please clean, disinfect and sterilize it. It is recommended to execute steam sterilization after washing with water or washing in ultrasonic cleaner.

3) Gutta-percha injection needle

After being used to each patient, please change the needle in time. When there is found or suspected damage to the needle, place it in a fixed recycling container.

4) Cleaning of heating chamber

When removing the residue inside the heating chamber and the loading slot, set the temperature of the device to 200 ° C, and then power off the device after squeezing all the residual materials out. After pulling the pushing ram out from back part, insert the supplied cleaning brush from the back of the device and pull it out from the front part of the

Melting and Filling Gun. Please take care not to add any cleaning agent or chemicals to the cleaning brush.

5) Pushing ram

Use sterile alcohol and gauze to remove any visible residue.

6) The gutta-percha injection needle, heat insulation hood, and wrench can be cleaned with clean water as well as can be cleaned in an ultrasonic cleaner;

7) After each use, please sterilize the gutta-percha injection needle, heat insulation hood, and wrench under high temperature and high pressure (134°C, 0.22MPa) for at least 4 minutes.

8) If the other accessories need to be cleaned or disinfected, please use gauze to pick up a small amount of water or disinfectant to wipe the surface. Do not soak those accessories in the cleaning solution.

9) Do not use volatile and diffluent solvents for cleaning, which will damage the surface of the device or cause the markings on the machine to fade.

8.2 Daily maintenance

When the device is not used, please turn off the power and unplug the power supply plug.

If the Melting and Filling Gun is in a low battery state for a long time, the service life of battery will be shortened. Please charge it in time if the battery level is low. When the device is not used, please charge it for 1 hour once a month.

8.3 Repair of device

This product does not contain self-repairing spare parts. Repair should be carried out by a designated professional or special repair shop.

9 Troubleshooting

| Fault | Cause | Solution |
|--|---|--|
| After pressing the “ON/OFF” button, the device is still off. | <ol style="list-style-type: none"> 1. Inadequate battery power 2. Battery is damaged. 3. The charging interface is short-circuited, causing the lithium battery to enter a protection state; 4. Melting and Filling Gun is damaged. | <ol style="list-style-type: none"> 1. Connect to power supply to charge. / Replace the battery. 2. Replace the battery. 3. Remove the substance that causes the short circuit, put the device into the charging base to charge, and then the device will return to normal; 4. Contact local distributor or manufacturer. |
| Gutta-percha cannot flow out from the needle | <ol style="list-style-type: none"> 1. The push ram has been pushed to the end, indicating that the gutta-percha has run out. 2. The pushing ram seal ring is damaged. 3. The injection needle is damaged and blocked | <ol style="list-style-type: none"> 1. Pull back the pushing ram and load a new gutta-percha stick 2. Replace the pushing ram 3. Replace the injection needle |
| Automatic shutdown | If there is no operation for 10 minutes, the device will automatic powers off | Reboot |
| The pushing ram cannot be pulled out | The portion of the pushing ram that enters the interior of the heating chamber is fixed by the cooling of the gutta-percha. | <ol style="list-style-type: none"> 1. Power on and set the temperature to 200 °C. After the temperature reaches the set value, pull out the pushing ram back; 2. Contact your local dealer or our company. |

| | | |
|--|--|---|
| Charging failure after connecting to power supply. | 1. The power supply is not correctly connected; 2. The power supply is damaged, or the specification doesn't match. 3. There are impurities on the contact thimble of charging base. | 1. Unplug and reconnect. 2. Replace the battery. 3. Wipe the thimble with alcohol, dry it, and reconnect. |
| The service time after each charging is shortened. | The battery capacity becomes smaller. | Send to the repair center. |
| ERROR code appears on display screen. | The heating chamber is damaged. | 1. Send to the repair center. 2. Contact local distributor or manufacturer. |

If the problem still cannot be solved, please contact your local dealer or our company.

1. When the pushing ram is in the Melting and Filling Gun, please do not push or pull the pushing ram vigorously. When the gutta-percha is heated up to the preset temperature, the pushing ram should be pushed by pulling the trigger for multiple times. If the pushing ram does not move, try to push it manually with a slight force, and try to pull the trigger.

2. Please refer to the recommended temperature to set the preset temperature.

3. To remove all remaining material, please first remove the injection needle, and then pull the trigger to squeeze out all the residual material in the heating chambers. Be careful not to touch the head of the Melting and Filling Gun to avoid scalding. Power off, cool it down slightly, and push the pushing ram down.

10 After-sales service

Since the date of sales, if the device cannot work normally for quality problem, our company will be responsible for the repair of device during the warranty period. Please refer to the Warranty Card for warranty period and warranty scope.

11 Environment protection

The device does not contain any harmful ingredients. It can be handled or destroyed in accordance with the relevant local regulations.

Note:

1) Without Woodpecker agreement and authorization, private modification of device may result in the electromagnetic compatibility problem of that device or other devices.

2) The design and test of Melting and Filling Gun complies with the related operation regulations of electromagnetic compatibility.

12 Statement

Woodpecker reserves the right to change the design of the equipment, the technique, fittings, instruction manual and the content of the original packing list at any time without further notice. The pictures are only for reference. The final interpretation rights belong to Guilin Woodpecker Medical Instrument Co., Ltd.

Introduction

Thank you for purchase Fi-P Heating and Packing Instrument developed by Guilin Woodpecker Medical Instrument Co., Ltd, a Hi-tech enterprise developing, manufacturing, and selling dental instruments. Woodpecker has excellent Quality Control System. To guarantee correct and safe operation, please read this Instruction Manual carefully before use. Depending on the level of risk involved, safety requirements are classed under the following indications:

- ⚠ Danger: (always referred to personal injury)
- ⚠ Warning: (referred to possible damage to property)

1 Product introduction

1.1 Intended use

It is used to provide heat to the working tip, cut the gutta-percha point, and soften and pressurize the gutta-percha.

1.2 Diagram of components and control buttons

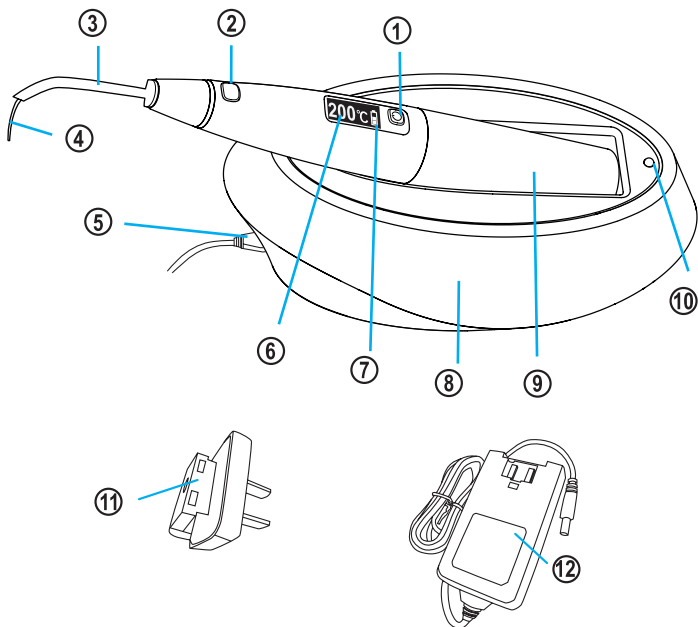

- | | |
|--------------------------------------|------------------------|
| 1. "ON/OFF" button | 2. Heating button |
| 3. Heat insulation sleeve | 4. Tip |
| 5. Connecting hole for power adapter | 6. Temperature |
| 7. Battery level | 8. Charging base |
| 9. Battery cartridge | 10. Charging indicator |
| 11. Power adapter plug | 12. Power adapter |
- 1) "ON/OFF" button:

Under shutdown state, shortly press "ON/OFF" button to start the device.

Under shutdown state, long press "ON/OFF" button to start the device and change the direction of screen display, that is to say, the direction of display can be change to adapt to the operation in left hand or right hand.

Under ON state, long press "ON/OFF" button to shut down the device. (Time for long press is about 1s.)

Note: If there is no operation for 10 minutes, the Heating and Packing Instrument will automatically shut down.

Under ON state, shortly press "ON/OFF" button to change the preset temperature of tip. The preset temperature will change to the next with the sequence 150°C→180°C→200°C→230°C after each press. And then go back to 150°C after short press at temperature of 230°C.



Figure 1 Preset temperature

2) Heating button:

Under the ON state, connect the tip, and press Heating button to start heating. Release the Heating button to stop heating, followed by the fall of tip temperature.

Note: If press and hold the Heating button for more than 10 seconds, the device will stop heating. If need to continue heating, please release the Heating button and press again.

3) Battery level:

The actual power of the battery is displayed in real time on the screen. When the battery is fully charged, the power of the OLED display is displayed as five grids. When the battery level is one grid, it indicates that the battery is low and needs to be charged in time. When the battery level is displayed as a space, it indicates that the battery is very low and needs to be charged immediately.

Note: During normal use, try not to let the battery level reduced to

space status (completely no power) before charge, which will shorten the service life of battery.

 **Warning:**

If the device has not been used for more than one month, the battery needs to be recharged. If the device is not in use for a long time, please be sure to charge it at least once a month to protect the battery. The service life of battery of Heating and Packing Instrument will be shortened when it is in a low battery state for a long time or when it leaves the charging base for a long time.

4) Temperature:

When the temperature is preset, the display screen shows the preset temperature value. About 1s after the temperature preset, the OLED screen will display the real-time temperature of the tip. When the Heating and Packing Instrument is in the heating state, the temperature indicator will simultaneously display the current temperature of the tip.

5) Charging base:

Firstly, connect the power adapter plug to the power adapter as shown in Figure 2. Then connect the power adapter to the power connecting hole on the charging base as shown in Figure 3 and connect the power adapter to a standard socket. Place the Heating and Packing Instrument correctly on the charging base as shown in Figure 4, so that the charging connector under the Heating and Packing Instrument can be reliably connected to the output connector of the charging base. When the Heating and Packing Instrument is properly connected to the charging base, the LED charging indicator on the base will be on constantly. If the LED is flashing or not lit, please check all the cables carefully.

There are charging status indicators on the charging base. When the Heating and Packing Instrument is not placed on the charging base, the indicator will flashes in yellow and green alternately. When the Heating and Packing Instrument is placed on the charging base, if the charging is being charged, the yellow indicator will be on constantly. When the battery is full, the yellow indicator will be off and the green indicator will be on constantly.

Notes: After receiving the device, please charge it immediately. Before use, please be sure that battery is fully charged. When the device is fully charged, the battery level of the Heating and Packing Instrument led display screen is the highest. After the battery runs out, the time of battery charging takes at least 2 hours and 30 minutes.

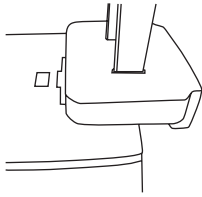

Figure 2 Installation of power adapter

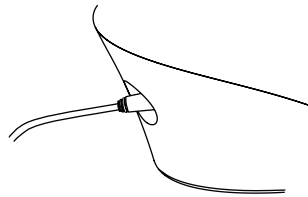

Figure 3 Connection to power supply

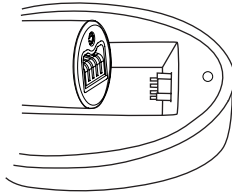

Figure 4 Charging

1.3 Device includes

1. Heating and Packing Instrument
2. Charging base
3. Power adapter with cord
4. Tips (The models are as shown in Table 2)
5. Heat insulation sleeve
6. Instruction Manual
7. Qualified Certification
8. Warranty card
9. Packing list

| Model | Tip Size(mm) | Taper |
|--------------|---------------------|--------------|
| WP4004 | 0.40 | 0.04 |
| WP4504 | 0.45 | 0.04 |
| WP5506 | 0.55 | 0.06 |
| WP5508 | 0.55 | 0.08 |

Table 2 Model of tips

1.4 Introduction and scope of application

1.4.1 Features:

- a) The display can be set to both right and left sides, to meet the needs of both left-hander and right-hander.
- b) Cordless design for Heating and Packing Instrument effectively broadens the operation space.
- c) Sensitive temperature control, simple display, and convenient operation; Press temperature setting button to set suitable working

temperature.

d) Four preset temperatures are for option: 150°C, 180°C, 200°C, 230°C.

e) If there is no operation for 10 minutes, the Heating and Packing Instrument will automatically shut down.

1.4.2 Scope of application:

Used in the root canal obturation stage in endodontic treatment.

1.5 Product specifications

| | | |
|--------|--------------------------------|-----------------------|
| Size | Heating and Packing Instrument | 23.8mm×158.3mm×23.8mm |
| | Charging base | 75.5mm×149.7mm×62.6mm |
| Weight | Heating and Packing Instrument | 80g |
| | Charging base | 195g |
| | Power adapter | 167g |

1.6 Technical parameters

| | | |
|-------------------------------|-------------------------------|------------------------------|
| Classification | Class II(AC/DC power adapter) | |
| Optional preset temperatures | 150°C→180°C→200°C→230°C | |
| Time consumption for charging | About 2.5h | |
| Power supply | Input | AC100V-240V 50/60Hz 800mA |
| | Output | DC15V/1.6A |
| Battery capacity | Chargeable battery | 2000mAh |

1.7 Environmental parameters

Temperature: +5°C ~ +40°C

Humidity: 30% ~ 75%

Air pressure: 70kPa ~ 106kPa

1.8 Storage and transport

1. The device should be handled carefully and lightly. Be sure that it is far from the vibration, and is installed or kept in a cool, dry, and ventilated place.

2. Do not store the device together with the articles that are combustible poisonous, caustic, or explosive.

3. The device should be stored in a room where the relative humidity is 10% ~ 93%, the air pressure is 70kPa ~ 106kPa, and the temperature is















-20°C ~ +55°C.

4. Please avoid the device from strong shock or vibration during transport. And please handle it carefully.

5. Please do not mix the device with hazardous articles during transport.

6. Please avoid the device from sun, rain, and snow during transport.

2 Standard icons

| | | | |
|--|--|---|-------------------------------------|
|  | Product serial number |  | Follow Instructions for Use |
|  | Manufacturer |  | Date of manufacture |
|  | Type B applied part |  | Class II device |
|  | Power switch | IPX0 | Ordinary equipment |
|  | Used indoor only |  | Device complies with WEEE directive |
|  | Can be autoclaved | DC 15V | DC 15V |
|  | Attention! Please refer to the accompanying documents. | | |
|  | Humidity limit for storage: 10% ~ 93% | | |
|  | Atmospheric pressure for storage: 70kPa ~ 106kPa | | |
|  | Temperature limit for storage: -20°C ~ +55°C | | |

3 Contraindications

1. People who are allergic to known natural latex and metals such as stainless steel, silver, copper, etc. are prohibited to use this device.

2. The patient with hemophilia is forbidden to use this device.

3. The patients with heart pacemaker are forbidden to use this device.

4. The dentists with heart pacemaker are forbidden to use this device.

5. Heart disease patients, pregnant women and children should be cautious to use the equipment.

4 Installation and disassembly method of accessories

4.1 Connection of power adapter

Connect the output point of power adapter to the charging base, and connect the input point to the socket that meets the standard of this power adapter. Please install in accordance with the procedures in Figure 2, Figure 3, and Figure 4. (Note: The installation in Figure 2 had been finished before delivery.)

4.2 Installation and removal of tip

1. After turning off the power switch, you can directly pull the tip off the Heating and Packing Instrument.

2. Place the used tip in a certain container and disinfect it.

3. Select the desired work tip and the hexagonal plug on the tip (as indicated by the red arrow in Figure 5). When installing the work tip as shown in Figure 6, you can select the appropriate direction according to the usage to insert the tip into the Heating and Packing Instrument.

4. Install the heat insulation sleeve to the tip as shown in Figure 7, to prevent scalding patient's mouth during operation.

5. Under ON state, if the tip hasn't been installed or is in poor connection, there would be an error code on display screen as shown in Figure 8.

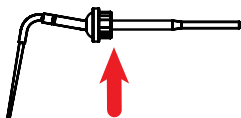

Figure 5 Tip

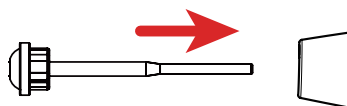

Figure 6 Installation of tip

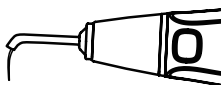

Figure 7 Installation of heat insulation sleeve



Figure 8 Error code

4.3 Installation and replacement of battery

When replacing the battery, as shown in Figure 9, first rotate the battery barrel counterclockwise to remove the battery tube, then take the old battery out of the battery tube, replace it with a new one, and finally tighten the battery tube clockwise according to the corresponding thread.

Note: When removing the battery, the screw under the battery barrel (pointed by the arrow in Figure 9) does not need to be unscrewed, just push the connector slightly inward to remove the battery.

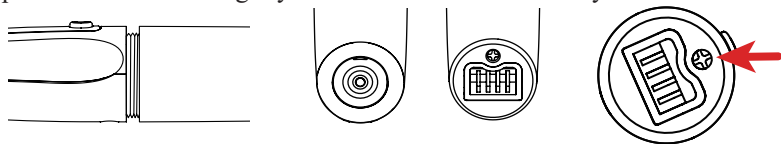

Figure 9 Replacement of battery

5 Operation method

1. According to the situation of patient, select suitable tip and install it. When installing the tip, chose a suitable angle to install the tip.

Danger:

Don't turn on the device when installing the tip, to prevent scalding the user by mistakenly pressing the heating button.

2. After pressing the "ON/OFF" button, the display screen of Heating and Packing Instrument lights up and display the preheating temperature and power status.

3. According to the actual situation, lightly press the temperature setting button, and select suitable preheating temperature as per the instruction on display screen.

4. During operation, lightly press the heating button so as to heat up to the preset temperature, soften and pressurizing the gutta-percha with careful, continuous and stable motion with the help of vertical pressurizer.

Note: The continuous heating time on gutta-percha cannot exceed 4s, or there would be risk of scalding.

5. After operation, please clean, disinfect, and sterilize the tip. The specific method is shown in Chapter 8.1.

6 Charging instruction

6.1 Use the corresponding charging base for this device. Connect the power adapter with the charging base, connect the power supply, and then correctly place the Heating and Packing Instrument into the charging base.

6.2 The battery used in this product has no memory and can be used at any time or charged at any time.

6.3 Before first use of this device, please charge it at least for 3 hours.

7 Safety precautions

1. Do not polish the tip.
 2. Do not knock or scratch the Heating and Packing Instrument.
 3. Do not place the Heating and Packing Instrument near an electronic device, phone, radio or HD/satellite TV as these may affect the temperature control of the Heating and Packing Instrument.
 4. Keep the heating pressurizer, tip, etc. under heating state away from inflammable and explosive materials.
 5. Please keep the device clean before and after operation. Before each use, please disinfect tip and its accessories.
 6. Users should be equipped with adequate protection such as goggles, mask, etc. to prevent cross-infection.
 7. The product should be in strict accordance with relevant operation specifications of medical authority and relative regulations. The product can only be operated by trained doctors or technicians.
 8. Do not install, remove, or replace the tip under heating state. Please power off before replace the tip.
 9. The tip must be correctly installed to prevent it from falling off.
 10. When the working tip is bent or worn, it will cause uneven heating. The operator should replace the tip in time according to the clinical conditions;
 11. After operation, please turn off the power immediately.
- Woodpecker is specialized in producing medical instrument. We are only responsible for the safety on the following conditions:
- a) The maintenance, repair, and modification are made by the manufacturer or the authorized dealers.
 - b) The charged components are original of “Woodpecker” and operated according to instruction manual.

8 Maintenance

8.1 Cleaning, disinfection and sterilization

1. The tip can be cleaned with clean water as well as can be cleaned in an ultrasonic cleaner.
2. After each use, please sterilize the tip under high temperature and high pressure (134°C, 0.22MPa) for at least 4 minutes.

3. If the other accessories need to be cleaned or disinfected, please use gauze to pick up a small amount of water or disinfectant to wipe the surface. Do not soak.

4. Do not use volatile and diffluent solvents for cleaning, which will damage the surface of the device or cause the markings on the machine to fade.

8.2 Daily maintenance

1. When the device is not used, please turn off the power and unplug the power supply plug.

2. If the Heating and Packing Instrument is in a low battery state for a long time, the service life of battery will be shortened. Please charge it in time if the battery level is low.

3. When the device is not used, please charge it for 1 hour once a month.

8.3 Repair of device

This product does not contain self-repairing spare parts. Repair should be carried out by a designated professional or special repair shop.

9 Troubleshooting

| Fault | Cause | Solution |
|-----------------------------|--|---|
| No indications, no response | 1. Inadequate battery power 2. Battery is damaged. 3. The charging interface is short-circuited, causing the lithium battery to enter a protection state; 4. Heating and Packing Instrument is damaged. | 1. Connect to power supply to charge. / Replace the battery. 2. Replace the battery. 3. Remove the substance that causes the short circuit, put the device into the charging base to charge, and then the device will return to normal; 4. Contact local distributor or manufacturer. |
| Automatic shutdown | If there is no operation for 10 minutes, the device will automatic powers off. | Reboot |

| | | |
|---|--|---|
| Tip works abnormally | 1. The tip is damaged. 2. Malfunction of main unit | 1. Replace the tip 2. Send it to the repair center. |
| Charging failure after connecting to power supply | 1. The power supply is not correctly connected; 2. The power supply is damaged, or the specification doesn't match. 3. There are impurities on the contact thimble of charging base. | 1. Unplug and reconnect. 2. Replace the battery. 3. Wipe the thimble with alcohol, dry it, and reconnect. |
| The service time after each charging is shortened | The battery ages and the battery capacity become smaller. | Contact local distributor or manufacturer to buy new batteries for replacement. |
| OPEN code appears on display screen | 1. The tip is damaged. 2. The tip is not installed. 3. The tip is not well installed. | 1. Replace the tip. 2. Install the tip. 3. Unplug the tip, and reconnect. |

If the problem still cannot be solved, please contact your local dealer or our company.

10 After-sales service

Since the date of sales, if the device cannot work normally for quality problem, our company will be responsible for the repair of device during the warranty period. Please refer to the Warranty Card for warranty period and warranty scope.

11 Environment protection

The device does not contain any harmful ingredients. It can be handled or destroyed in accordance with the relevant local regulations.

Note:

1) Without Woodpecker agreement and authorization, private modification of device may result in the electromagnetic compatibility problem of that device or other devices.

2) The design and test of Heating and Packing Instrument complies with the related operation regulations of electromagnetic compatibility.

12 Statement

Woodpecker reserves the right to change the design of the equipment, the technique, fittings, instruction manual and the content of the original packing list at any time without further notice. The pictures are only for reference. The final interpretation rights belong to Guilin Woodpecker Medical Instrument Co., Ltd.

Scan and Login website
for more information



Guilin Woodpecker Medical Instrument Co., Ltd.
Information Industrial Park, Guilin National High-Tech
Zone, Guilin, Guangxi, 541004 P. R. China

Europe Sales Dept. Tel: +86-773-5873196

North America, South America &

Oceania Sales Dept. Tel:+86-773-5873198

Asia & Africa Sales Dept. Tel:+86-773-5855350

Fax: +86-773-5822450

E-mail: woodpecker@glwoodpecker.com, sales@glwoodpecker.com

Website: <http://www.glwoodpecker.com>

ZMN/WI-09-458 V1. 3- 20190603